

|C|D|A|

SL550 SL570

Thirteen function pyrolitic oven

Use and maintenance

Contents

3	Important information	18	Rapid preheating
5	First use of the oven	18	Oven preheat
5	Standby mode	18	Temperature
6	Control panel	19	Cooling fan and residual heat
8	Function indicator symbols	19	Lighting
8	Setting the time	20	Pyrolitic cleaning
9	Minute minder	22	Cleaning and maintenance
9	Child lock	29	Changing the oven light bulbs
10	Semi automatic cooking	30	Installation
11	Automatic cooking	32	Mains electrical connection
12	Using the grill	34	Technical assistance
12	ECO heating	35	Error codes
13	Operations	36	Specifications
14	Preset programmes	37	Product fiche
15	Practical tips	38	Product information
16	Temperature probe (SL570 only)		

IMPORTANT: Please read the user instructions carefully before using the appliance for the first time and before installing it. Failure to install the oven, or to have it installed, as per the instruction manual could invalidate the warranty. Any service calls relating to misuse or incorrect installation could incur a service charge.

Important information

This appliance must only be used for the purpose for which it is intended, i.e. domestic cooking. Any other use could be dangerous and may lead to premature failure of the appliance.

The CDA Group Ltd. cannot be held responsible for injuries or losses caused by incorrect use or installation of this product. Please note that CDA reserves the right to invalidate the guarantee supplied with this product following incorrect installation or misuse of the appliance.

Under no circumstances should any external covers be removed for servicing or maintenance except by suitably qualified personnel.

User information

- The appliance and its accessible parts become hot during use. Care should be taken to avoid touching heating elements
- The appliance can be used by children aged from 8 years and above. Persons with reduced physical, sensory or mental capabilities must be given instruction or supervision concerning safe operation of the appliance and understand the hazards involved
- Do not allow anyone unfamiliar with the contents of this instruction manual to operate the oven
- Do not use harsh cleaning agents or sharp metal objects to clean the door as they can scratch the surface potentially resulting in cracking or shattering of the glass
- Take care when opening the oven door during or after a cooking cycle as hot steam may escape
- Do not use the oven in the event of a technical fault. Any faults must be fixed by an appropriately qualified and authorised person
- In the event of an incident due to a technical fault, disconnect the power and report the fault to CDA Customer Care
- The appliance has been designed only for cooking, any other use may invalidate your warranty and cause danger
- Do not place anything weighing over 15kg on the opened oven door

Appliance information

Please enter the details on the appliance rating plate below for reference, to assist CDA Customer Care in the event of a fault with your appliance and to register your appliance for guarantee purposes.

Appliance Model	
------------------------	--

Serial Number	
----------------------	--

EU Declarations of Conformity:

This appliance has been manufactured to the strictest standards and complies with all applicable legislation and the following European Directives.

- The Low Voltage Directive 2014/35/EU
- Electromagnetic Compatibility Directive 2014/30/EU
- ErP Directive 2009/125/EU

The product has been marked with the **CE** symbol and the Declaration of Conformity has been issued to the manufacturer and is available to the competent authorities regulating the market

IMPORTANT INFORMATION FOR CORRECT DISPOSAL OF THE PRODUCT IN ACCORDANCE WITH EC DIRECTIVE 2012/19/EU.

At the end of its working life, the product must be taken to a special local authority waste collection centre or to a dealer providing appliance recycling services.

Disposing of a household appliance separately avoids possible negative consequences for the environment and health. It also enables the constituent materials to be recovered, saving both energy and resources. As a reminder of the need to dispose of household appliances separately, the product is marked with a crossed-out wheeled dustbin .

First use of the oven

In order to remove oil residues accumulated during the manufacturing process and dust accumulated during storage and transport, we recommend a preliminary cleaning before first use. This is to protect your health and provide optimum quality in cooking.

IMPORTANT!

Remove the protective foil from the telescopic runners before using the oven.

Preliminary heating

1. Remove any packaging elements from the oven cavity
2. Turn on ventilation or extractor fan in the room or open a window
3. Set the oven to 250°C using the rapid preheating function
4. Allow to heat for approximately 30 minutes
5. Turn oven off and allow to cool
6. To clean the oven use a well wrung-out cloth with warm water and a small amount of washing up liquid
7. Dry with a clean cloth

A slightly unpleasant smell may be emitted during this process due to the vaporising of oil residue used to protect the oven during storage.

Standby mode

Switching the appliance to standby mode resets all functions settings, times, temperature and automatic programmes. All heating elements are deactivated and the display is dimmed except for the timer.

To enter standby mode, press the ① sensor for 3 seconds at any time (this is applicable even if the oven is locked). A beep will be heard indicating the mode is active. To exit standby mode simply press the ① sensor for 3 seconds, a different beep will be heard to indicate the oven is now ready for operation.

Control panel

The control panel is equipped with an LED display and backlit touch sensors.

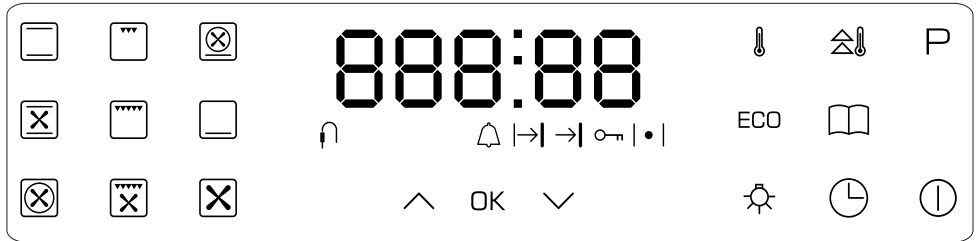

Conventional oven

The thermostat enables the user to set the temperature within a range of 30°C to 280°C. This setting is ideal for baking cakes, meat, fish, bread. For best results preheat the oven and use a baking tray on one level.



Half grill

This function radiates heat from the grill element. This fully temperature variable grill can be set between 30°C and 280°C maximum.



Fan cooking with lower heat

With this setting the convection fan and bottom heater are on, which increases the temperature at the bottom of the cooked dish. Intense heat from the bottom is ideal for moist cakes and pizza.



Fan assisted oven

This setting is most suitable for baking cakes.



Full grill

In this setting both the grill and top element are engaged. This increases the temperature in the top part of the oven chamber making it suitable for browning and grilling larger portions of food. It can be set between 30°C and 280°C maximum.



Warming oven

This function radiates heat from the bottom element, baking cakes from underneath until done.



Fan oven

This function uses the circular heating element with a temperature between 30°C and 280°C. The fan then circulates the hot air which helps to achieve uniform heat distribution.



Fanned full grill

This function radiates heat from the grill element and the top element but also uses the fan to circulate hot air. The hot air is distributed over and under the food that you are grilling. This fully temperature variable grill is ideal for grilling fish or other items where the appearance could be spoiled by a normal grill function. It can be set between 30°C and 280°C maximum.



Defrost

This function uses the fan to circulate air at ambient temperature within the oven which helps to accelerate the defrosting process.



**On/off switch
(standby)**



Rapid preheating



Clock / Minute minder



Set Temperature



Light



Plus sensor



Pre-set programmes



Minus Sensor

ECO

Eco programme







OK

Confirm sensor



Steam cleaning

Function indicator symbols

 Minute minder active	 Pyrolitic cleaning
 Duration	 Temperature probe connected (SL570 only)
 End time	
 Child lock active	
 Heating active	

Setting the time

When the appliance is connected to power, the display will show the hour digits flashing, the minute digits will be illuminated.

- Use \wedge and \vee to set the hours. Touch **OK** to confirm the setting, the hour digits will now be illuminated and the minutes will be flashing
- Use \wedge and \vee to set the minutes. Touch the **OK** sensor to confirm the setting. The appliance enters sleep mode and the time set will be shown







Note: The time can only be set in 24 hour format

Changing the time

The time display can only be changed when no other functions are being used.









If in sleep mode, press the on/off sensor $\textcircled{1}$ to wake the appliance up. Once the display has illuminated, touch and hold $\textcircled{2}$. The $\textcircled{3}$ symbol will flash on the display. Touch $\textcircled{4}$ again and the digits will start to flash. You can now proceed to set the time following the steps in the 'Setting the time' section above.

Child lock

Child lock is intended to prevent changes to the oven settings and the oven being turned on. When the appliance is on simultaneously touch and hold  and  for 3 seconds to activate the child lock. The  symbol will be illuminated. When the child lock is activated in standby mode it prevents the oven from being turned on. When the child lock is activated when the appliance is in use, it prevents the settings from being changed but the oven can still be turned off. To turn the child lock off simply touch and hold 3 seconds and the  and  sensors and the  symbol will go out.

Minute minder

During a cooking function, only the minute minder can be set or adjusted. The clock or delayed cooking time can not be set or adjusted during the function.









- Touch and hold  and the display will show the  symbol
- Touch the  and  sensors to adjust the the setting and touch **OK** to confirm. Touch and hold the  and  sensors to clear the setting. The  symbol will be illuminated on the display, indicating the time is set
- Once the time has elapsed you will hear a beeping and the  symbol will be flashing. Touch the **OK** sensor to silence the beeping and end the function

The minute minder can be set for a maximum of 2 hours.



Semi automatic cooking

This function allows for a cooking time to be set. When the set time elapses the oven will switch the set function off and an acoustic signal will sound to alert the user. The cooking time available ranges from between 1 minute and 10 hours.

To switch on semi automatic cooking

- First select a heating function and temperature
- Touch and hold  and the  symbol will flash on the display
- Touch  again and the  symbol will appear on the display
- Use the  and  sensors to adjust the duration as needed and touch **OK** to confirm the setting or alternatively wait 5 seconds and the duration will automatically set
- To clear the duration setting, simultaneously touch  and  and the display will show 0:00. Touch **OK** to confirm











During the cooking process the  symbol will be illuminated.

Once the duration time has elapsed you will hear beeping. Touch any sensor except  to mute the beeping. The function settings and temperature will clear and the lighting will turn on for 30 seconds. The  symbol will go out and the appliance will turn off after 60 seconds.



Automatic cooking

This function allows for a duration and an end time to be set for cooking. For example, if you set the cooking duration to 1 hour, and the end time to 15:00, then the oven will activate the function at 14:00.

To switch on automatic cooking

- First select a heating function and temperature
- Touch and hold  and the  symbol will flash on the display
- Touch  again and the  symbol will appear on the display
- Use the  and  sensors to adjust the duration as needed
- Touch  and the  symbol will flash on the display and the end time will also be shown
- Use the  and  sensors to adjust the end time and touch **OK** to confirm the setting

During the cooking process both the  and  symbols will be illuminated.

Once the duration time has elapsed you will hear beeping. Touch any sensor except  to mute the beeping. The function settings and temperature will clear and the lighting will turn on for 30 seconds. The  symbol will go out and the appliance will turn off after 60 seconds.

Using the grill

Important!













When using any grill functions the oven door should be kept closed. When the grill is in use accessible parts can become hot and it is advisable to keep children away from the oven. When using the half grill, full grill or fanned grill functions the maximum temperature that can be set is 280°C.

ECO heating



ECO heating is an optimised heating function designed to save energy when preparing food. You cannot reduce the cooking time by setting a higher temperature; preheating the oven is not recommended. Do not change the temperature setting and do not open the oven door during cooking. The levels listed in the table below can be found around the edge of the oven cavity when the door is open



















Type of dish	Oven function	Temperature °C	Level	Time (min)
Sponge cake	ECO	180 - 200	2-3	50 -70
Muffins	ECO	180 - 200	2	50 -70
Fish	ECO	190 - 210	2-3	45 - 60
Beef	ECO	200 - 220	2	90 - 120
Pork	ECO	200 - 220	2	90 - 160
Chicken	ECO	180 - 200	2	80 - 100

Operations

Function Description		Oven Elements						Temperature [°C]		Default Temperature [°C]
		Lighting	Top	Grill	Circular	Bottom	Fan	Min.	Max	
Heating functions										
	Conventional Oven	✓	✓			✓		30	280	200
	Fan assisted oven	✓	✓			✓	✓	30	280	180
	Fan oven	✓			✓		✓	30	280	180
	Half grill	✓		✓				30	280	250
	Full grill	✓	✓	✓				30	280	250
	Fanned full grill	✓	✓	✓			✓	30	280	200
	Fan cooking with lower heat	✓			✓	✓	✓	30	280	220
	Warming oven	✓				✓		30	240	200
	Defrost	✓					✓	-	-	-
<p>To change heating functions during cooking simply select the function you want on the control panel and touch OK to confirm.</p>										
Additional functions										
	Temperature	See page 17 for info								
ECO	ECO programme	See page 12 for info						30	280	200
	Lighting	✓						-	-	-
	Rapid pre-heating	✓	✓		✓		✓	30	280	180
	Pre-set programmes	See page 14 for info								
P	Pyrolytic cleaning		✓	✓		✓		-	-	410

















Pre-set programmes

This oven features a number of preset programmes which create the ideal cooking environment (time, temperature etc.) for certain dishes. These can be accessed by pressing the  sensor and cycling through the programmes in the table below using the  and  sensors. Touch **OK** to confirm the programme and the oven will commence operation. The levels listed in the table below can be found around the edge of the oven cavity when the door is open.

Programme	Description	Rapid pre-heating	Heating Function	Level	Time [Min]	Temperature [°C]
P01	Beef			2	120	180
P02	Pork			2	120	180
P03	Lamb			2	120	180
P04	Chicken 1.5kg			2	85	190
P05	Duck 1.8kg			2	90	180
P06	Goose 3kg			1	130	170
P07	Turkey 2.5kg			1	155	170
P08	Pizza	✓		2	15	220
P09	Lasagne	✓		2	25	200
P10	Focaccia	✓		2	15	230
P11	Casserole with pasta	✓		2	15	220
P12	Baked vegetables	✓		2	35	180
P13	Sponge cake	✓		2	45	160
P14	Muffins			3	35	160
P15	Cookies			3	20	150
P16	Fruitcake	✓		2	55	175
P17	Bread			2	60	180
P18	Dough proving			2	20	30
P19	Dry			2/3	300	50

Practical tips

The times given in the table below apply to a dish that is placed in to a cold oven. For a preheated oven the times should be reduced by 5 - 10 minutes. The figures given below are approximate and can be altered based on your own experience and cooking preferences. The levels listed in the table below can be found around the edge of the oven cavity when the door is open.

Type of dish	Heating Function	Level	Time [Min]	Temperature [°C]
Sponge cake		2 - 3	30 - 50	160 - 200
Muffins		3	25 - 40	160 - 170
Muffins		3	25 - 40	155 - 170
Pizza		2 - 3	15 - 25	200 - 230
Fish		2	45 - 60	210 - 220
Fish		2 - 3	45 - 60	160 - 180
Fish		2 - 3	60 - 70	190
Sausages		4	14 - 18	220
Beef		2	120 - 150	225 - 250
Beef		2	120 - 160	160 - 180
Pork		2	90 - 120	160 - 230
Pork		2	90 - 120	160 - 190
Chicken		2	70 - 90	180 - 190
Chicken		2	45 - 60	160 - 180
Chicken		2	60 - 70	175 - 190
Vegetables		2	40 - 50	190 - 210
Vegetables		3	40 - 50	170 - 190

Temperature probe (SL570 only)

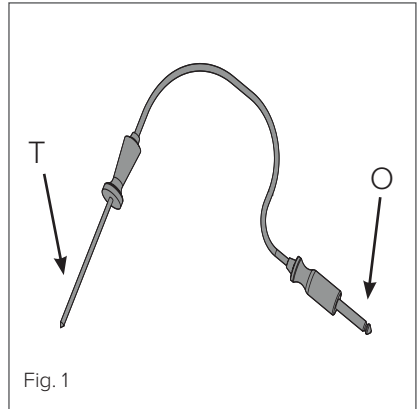

This oven comes with a temperature probe which allows you to cook food until it is a certain temperature inside. To use the temperature probe, simply follow the steps below:

- Insert the end marked 'O' (Fig. 1) into the oven probe socket, located on the right side of the oven cavity (Fig. 2). Push the probe in until it clicks and sits firmly and the probe indication  switches on on the display panel
- Insert the end marked 'T' (Fig. 2) into the food to be cooked

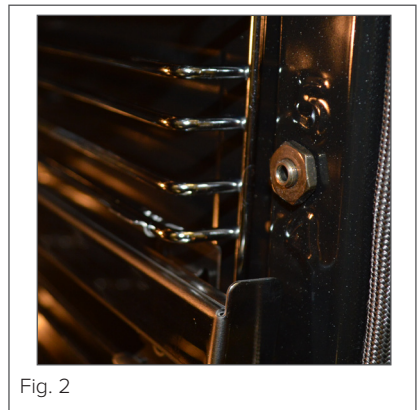

- If you switch the oven, or a function, on with the temperature probe already plugged in you will be prompted to enter the desired probe temperature first. If you plug the temperature probe in after activating a function, then you will be prompted to enter the desired temperature



- The display will show the target temperature flashing on the left (default 75°C) and the current probe temperature on the right. Use  and  to adjust the target temperature and touch  to confirm or wait 5 seconds to abort and restore the previous setting

- Once the set probe temperature has been reached, the function will switch off. If you are using a programme with a duration (e.g. semi-automatic cooking) as well as the temperature probe, then the function will operate until the first condition to end the programme is met, i.e. until the probe temperature is reached or duration has elapsed

Below are recommended temperatures depending upon the type of meat being cooked in conjunction with the temperature probe.



Type of meat	Ideal temperature °C
Pork	85 - 90
Beef	80 - 85
Veal	75 - 80
Lamb	80 - 85
Venison	80 - 85

Please note:

- You must only use the temperature probe approved for this oven.
- Always check that the food being cooked is done thoroughly before serving it to anyone.
- If you need to remove the temperature probe mid-function, ensure that you wear adequate PPE (Personal Protective Equipment) for the task (e.g. protect your hands, arms and face).
- Removing the temperature probe mid-function will cause the oven to go into an error state and stop the function.
- Some preset programmes require the temperature probe to be present or removed. Prompts will be displayed in cases such as these. You have approximately 1 minute to do as prompted before the oven cancels the selection.

Rapid preheating

The rapid preheating function allows the oven elements to work at their maximum capability in order to get the oven to temperature as quickly as possible. To use the rapid heating function, follow the steps below.

- First select a heating function and temperature
- Touch the  sensor and the function will start
- The  sensor will be illuminated until the temperature set has been reached, upon which the sensor will go out and the function will stop
- The function can be turned off at any time by pressing 

Oven preheat

When the |•| symbol is illuminated, it indicates the oven is heating up towards the temperature set. The |•| symbol will go out once the temperature is reached. To show the set temperature is being maintained The |•| symbol will illuminate and go out periodically.



Temperature

At any time during a heating function, it is possible to find out what temperature the oven is currently operating at. Simply touch the  sensor to see what the temperature inside the cavity is. Touch the sensor a second time and the display will show the temperature which has been set. Touch the sensor a third time and the display will revert back to the current time.

Cooling fan and residual heat

If the oven has no active functions but the temperature inside is still above 80°C, the cooling fan will activate automatically until the temperature decreases. During this cooling period the display will show the current temperature until the oven has cooled sufficiently.

Lighting

The lighting inside the cavity of the oven can be turned on at any time during an active function by pressing the  sensor. The light will stay on for 30 seconds but can be switched on permanently if the  sensor is pressed for 3 seconds. To deactivate simply press the  sensor again for 3 seconds.

Pyrolytic cleaning

This function heats the oven to approximately 410°C which will burn off or loosen any stubborn grease, stains or dirt inside the oven, leaving behind an ash that simply has to be wiped up or swept from the interior afterwards.

Note: Before using this function, read the chapter on cleaning and maintenance within this instruction manual, in particular how to remove any internal furniture from the oven.

The cleaning process

- Remove **all** items from the oven (baking trays and side racks) as these can be damaged during the process
- Close the oven door
- Touch the **P** sensor on the control panel
- The display will show the duration 2:00 hours. Touch **^** and **v** to adjust the duration to 2:30 or 3:00 hours and touch **OK** to confirm the duration and the cleaning process will start
- If the oven door is still open during these first few steps, the **P** symbol will flash, signifying the door lock isn't engaged. If the door is not closed within 10 seconds the pyrolytic cleaning process will be aborted. When the door is locked the **P** symbol stays illuminated and the internal lighting is off

Notes

- Temperature inside the oven cavity can exceed 410°C - Ensure no children are near the appliance during this process
- 75 minutes before pyrolytic cleaning is complete, the heating elements are disconnected and the current internal temperature is displayed and the appliance begins to cool down
- The oven door will be unlocked when the temperature inside the oven cavity cools down to 150°C and the **P** symbol on the display will go out

- You cannot change the duration of the pyrolytic cleaning while the process is in action
- Touch **⏏** to abort the pyrolytic cleaning process. The door will only unlock if the temperature inside the oven has cooled sufficiently
- If there is a power outage during the pyrolytic cleaning process and the power is restored, the appliance will start the cooling down process and will unlock once the oven has cooled down to a safe temperature
- When you touch **OK** to start the pyrolytic cleaning process and open the door before it is locked, you will hear a beeping and the pyrolytic cleaning process will be aborted

Cleaning and maintenance

Keeping your oven clean and well maintained helps to prolong its fault-free lifespan. It is important that, before any cleaning or maintenance is performed, you switch off the oven at the mains supply. Do not start any cleaning or maintenance until the oven has been allowed to cool completely.

We recommend always wearing PPE (Personal Protective Equipment) when carrying out any cleaning or maintenance.

Cleaning the oven exterior

Stainless steel, aluminium and glass surfaces can all be cleaned using a dilute solution of water and mild detergent. They must be cleaned very carefully using a soft or microfibre cloth to avoid scratching and abrasions. Any abrasive cleaner (including Cif) will scratch the surface and could erase the control panel markings. Always dry thoroughly with a soft dry cloth.

Cleaning the oven interior

The oven should always be cleaned after use when it has been allowed to cool down. The cavity should be cleaned using a mild detergent solution and warm water and then wiped dry with a suitable clean cloth.

Cleaning the temperature probe

The temperature probe should be cleaned using warm soapy water and a clean cloth, The temperature probe is not suitable for use in a dishwasher

Cleaning and maintenance

Abrasive cleaning agents or scouring pads/cloths should not be used on the cavity surface.

IMPORTANT:

- **Steam cleaners must not be used when cleaning this appliance**
- **Once care and maintenance is complete, ensure that all parts are correctly replaced before using the oven**

Removing the appliance door

In order to allow easier access into the oven cavity for cleaning, it is possible to remove the door. Before removing the door, ensure that you have an area prepared in which you can place the removed door. This area should ideally be protected by something like a folded, dirt-free, towel to help prevent damage to surfaces and the door.

- Open the door fully
- Lift and tilt the safety catch part of the hinge (Fig. 3) so that it is fully extended and points towards the door
- Close the door most of the way, lift it slightly and then pull it, safely but firmly, towards you



Cleaning and maintenance

Replacing the appliance door

- Hold the door to the appliance in the closed position and manoeuvre the hinges so that the part of the hinge, highlighted by the star in fig. 4, inserts into the hinge slot in the cavity frame
- Next, ensure the notch on the underside of the hinge sits on the lip of the hinge slot. Open the door fully. Each hinge should be seated in the same way as the hinge in fig. 5. If it is not, follow the steps for removing the door and try replacing it again
- Finally, lift the safety catch part of the hinges back into place so that they are lying flat against the hinges

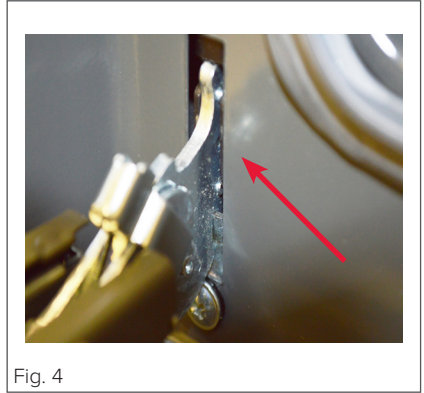

Fig. 4

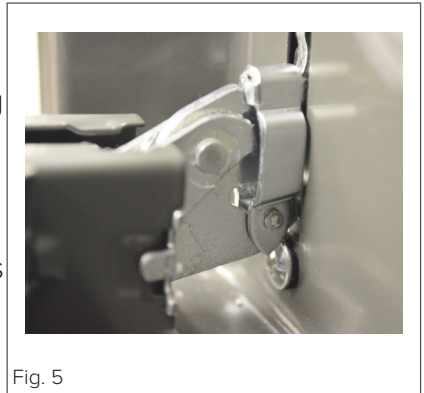

Fig. 5

Please note: If the hinge safety catches are not in the correct place then the door and/or appliance may receive damage when attempting to close the door.

Cleaning and maintenance

Important: Do not disassemble the door without it having been removed from the oven. Weight differences could cause the door to snap shut, causing damage to the oven and/or the user

Removing the inner door glass

With the door removed, the inner glass can also be taken out for cleaning purposes.

- Use a phillips screwdriver to undo and remove the screws in the upper door slat
- Use a flathead screwdriver to unhook the door slat, as shown in fig. 5
- Remove the door slat, as per fig. 6, and place it somewhere safe where it will neither receive nor cause damage
- Remove the inner glass from the blocks it is seated within (near to the hinges) and place this somewhere safe also. Pay attention to the way that the glass is facing as it will need to be replaced in the same direction.

The smooth surface of the glass

should be facing upwards (inwards if the door was back in place) with the patterned side facing the oven door handle

- Clean the door glass with warm, soapy water and wipe dry with a clean microfibre cloth

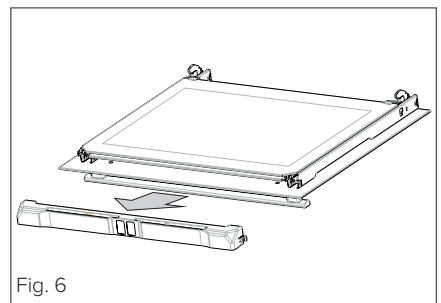
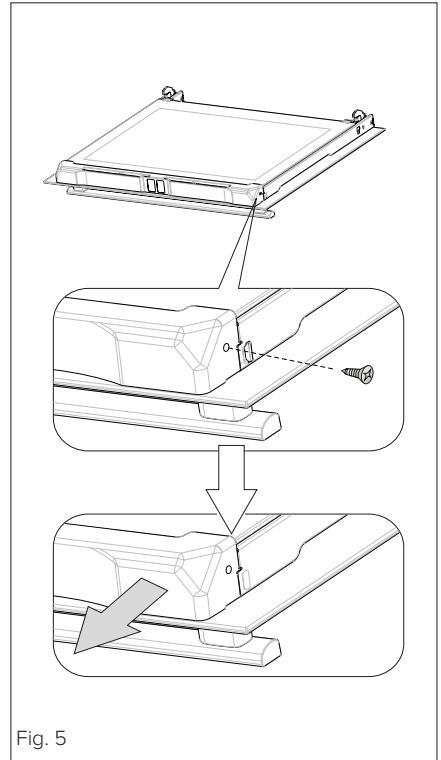

Cleaning and maintenance

- The middle pane of glass can also be removed but it is important that this pane is reinserted facing the same way that it was when removed
- There are a number of rubber guides attached to the inner pane and these must be returned to their original positions when reassembling the door. Fig. 7 shows these guides and their position on and around the inner glass
- Simply reverse these steps in order to reassemble the door. Take care when reattaching the upper door slat. Place the left side on first until you hear a 'click' as it connects and then attach the right side. This will help to avoid damaging the door and/or glass

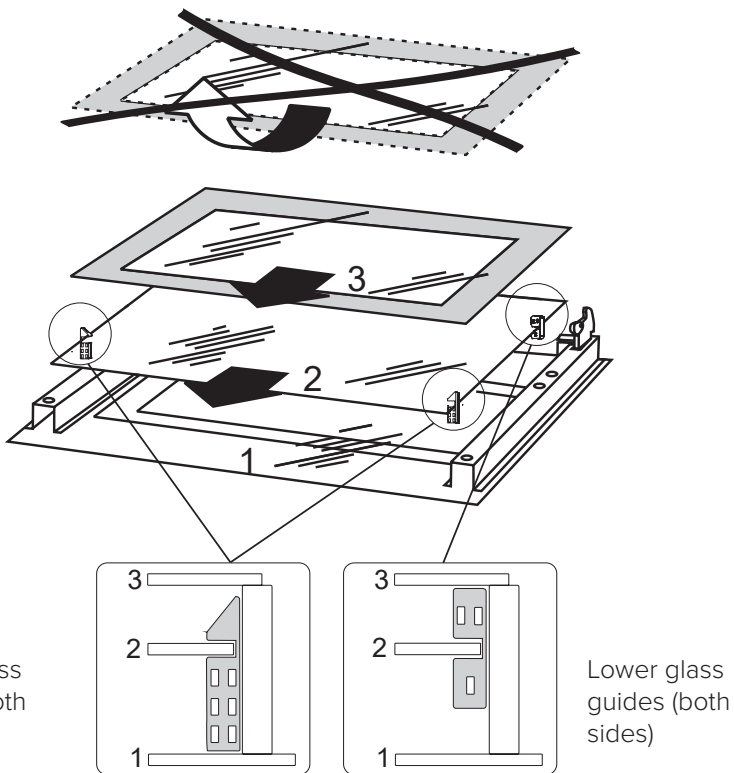

Fig. 7

Cleaning and maintenance

This oven is equipped with telescopic runners allowing you to remove large or heavy items from within the oven cavity safely and easily.

Removing the telescopic runners

- Offer your index finger up to the lower clip and rest your thumb on the upper clip as shown in fig. 8 below
- Pull upwards on the lower clip to release it from the side rack and the upper will also be free
- Repeat the process for the front and rear clips
- To reinstall the telescopic runners simply offer up the bottom clips to the side rack and gently ease the upper clips back on to the rack

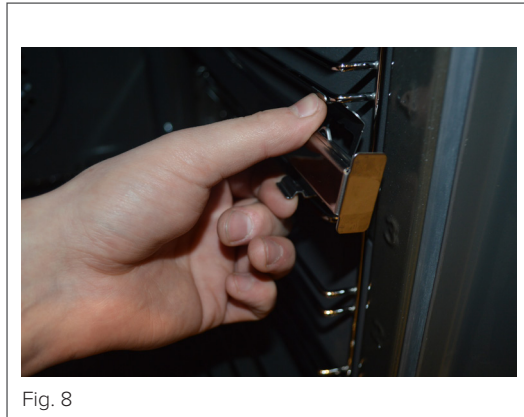

Important!

The telescopic runners should be removed before the shelf supports. The telescopic runners are not suitable for use in a dishwasher.

Cleaning and maintenance

Important:

Always remember to allow the oven to cool sufficiently, if it has been in use, before carrying out any maintenance.

To remove the shelf supports

- Take a firm hold of the shelf support in the middle. Place your thumb against the oven wall and lever the support out of the support holes (Fig. 9)
- Tilt the shelf support outwards (Fig. 10) and you should then be able to remove the shelf support arms that secure it into the cavity walls at the back

To replace the shelf supports

- Simply carry out the above steps, but in reverse order

Please note:

Take care not to damage the enamel walls of the oven, particularly around the shelf support arm holes.

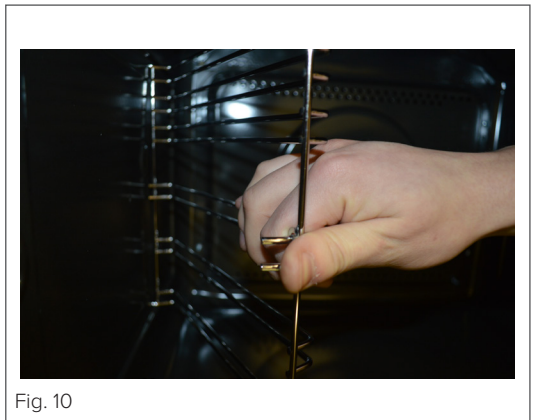
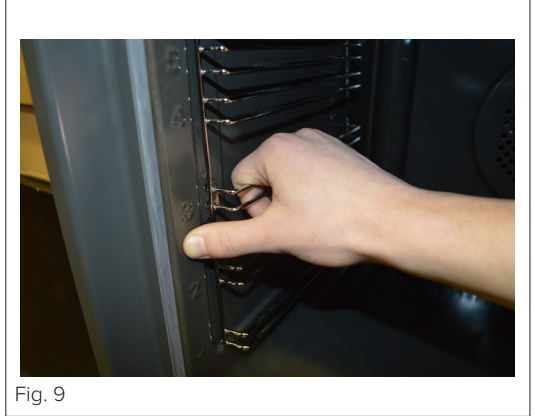

Changing the oven light bulbs

Important:

Before any maintenance is started involving electrical parts, the appliance must be disconnected from the power supply. If the oven has been in use, let the oven cavity and the heating elements cool down before attempting any maintenance.

Never use screwdrivers or other utensils to remove the light cover. This could damage the enamel of the oven or the lamp holder. Remove only by hand.

Never replace the bulb with bare hands as contamination from your fingers can cause premature failure. Always use a clean cloth or gloves. Old bulbs may still be hot!

Changing the bulb (Fig. 11)

- Remove all the pans, telescopic runners and shelf supports as shown on pages 27 and 28
- Carefully detach the glass cover by applying pressure with your thumb to one side whilst holding the other side with your fingers.
- Carefully remove the old bulb and insert a new bulb suitable for high temperatures (300°C) of the following specification; 230-240V~, 50Hz, 25W, G9 fitting
- Refit the glass cover cover

Please note:

The bulb replacement is not covered by your guarantee.



Fig. 11

Installation

Important! If installing this oven below a hob, ensure that the required air gap between the two appliances is observed. This gap is usually detailed in the hob's manual.

The installation of this appliance must be carried out by a suitably qualified person. We recommend seeking the help of another person for the installation process.

Do not install the oven in the direct vicinity of refrigerators or freezers. This could cause unnecessary energy consumption.

If the oven is being installed into a built under oven housing unit ensure that the front rail at the top of the unit is not installed as it could restrict ventilation.

Ensure that air can flow freely around the housing area. If the oven is being installed into a fully enclosed built-under oven housing unit it may be necessary to cut a small slot in the top of the plinth fitted under the unit. Cut a section

400mm wide and a minimum of 15mm high to allow air to pass under the unit. Alternatively cut a section 400 x 450 mm in the base of the carcass as indicated in Fig. 12. Failure to allow adequate ventilation to the appliance may result in overheating or damage to adjacent units and could invalidate the warranty.

This appliance is type X installation.

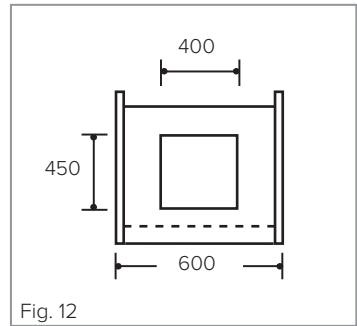

Installation

The walls of the kitchen units must be able to withstand temperatures of 75°C above ambient (typically this is between 90°C and 100°C). When correctly installed ensure that there is a gap of 4mm minimum between the sides of the oven and adjacent furniture doors.

How to install your oven

You will need the housing area in Fig. 13 to fit your oven correctly. The oven is designed to fit into a cabinet of 600 mm width. The oven can be built in or built under the kitchen units, but you must ensure that it is properly ventilated. In the diagram below the built-in oven is ventilated by means of a space at the top of the kitchen cabinet. There are many other methods of ventilating your oven - consult a qualified engineer for advice.

Lift the oven carefully into position on the shelf, taking care NOT to lift it by the door handle. If you lower the oven door, you will see 4 screw holes, 2 on each side of the oven (image B fig. 13). The oven should then be secured to the housing by securing screws into these

holes. Remember the housing should not be free-standing but be secured to the wall and/or adjacent fittings.

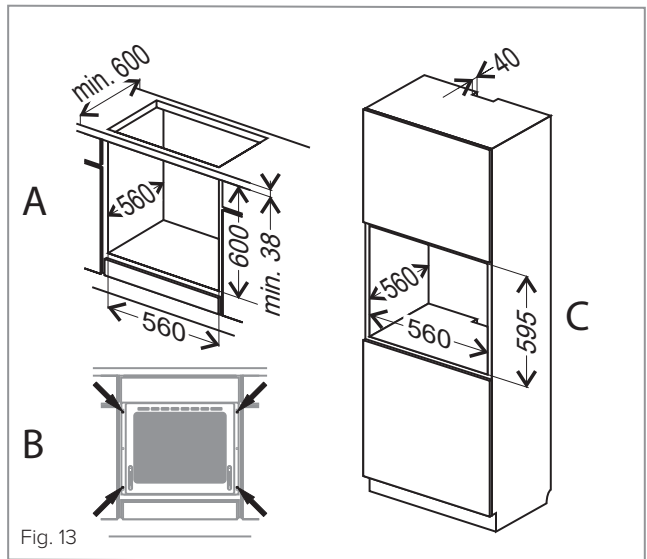

Mains electrical connection

Warning! This appliance must be earthed.

This appliance must be connected by a competent person, using fixed wiring via a double pole switched fused spur outlet, protected by a 13A fuse.

We recommend that the appliance is connected by a qualified electrician, who is a member of the N.I.C.E.I.C. and who will comply with the I.E.T. and local regulations. The wires in the mains lead are coloured in accordance with the following code:

GREEN AND YELLOW = EARTH
BLUE = NEUTRAL
BROWN = LIVE

As the colours of the wires in the mains lead for the appliance may not correspond with the coloured markings identifying the terminals in your spur box, proceed as follows:

1. The wire which is coloured green and yellow must be connected to the terminal marked E (Earth) or coloured green
2. The wire which is coloured blue must be connected to the terminal marked N (Neutral) or coloured black
3. The wire which is coloured brown must be connected to the terminal marked L (Live) or coloured red

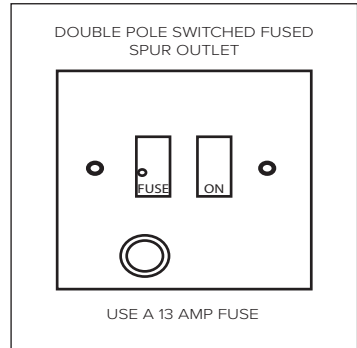

Mains electrical connection

Please note:

- The mains cable must only be replaced by a qualified electrician or service engineer and must be of equivalent or better rating (i.e. 3 x 1.5 mm², HO5VV-F)
- This appliance is intended to be connected to the mains supply with a cable of cross sectional area 1.5 mm²
- The current rating of the fuse or circuit breaker protecting this appliance should be marked on the socket outlet
- Assembly and electrical connection should be carried out by specialised personnel
- When installing this product we recommend you seek the help of another individual
- Should the mains cable be damaged or need to be replaced, it should only be done so by a qualified electrician or engineer. The terminal block on the appliance is clearly marked with regards to the positions of live, neutral and earth

Appliance electrical rating: 2800W

Technical assistance

In the event of your appliance requiring technical assistance and/or spare parts, please contact CDA Customer Care. For more information about the warranty of your product, including terms and conditions, please visit www.cda.eu/warranty

CDA Customer Care

Phone: 01949 862 012

Email: customer.care@cda.eu

In this case it is necessary to state all the appliance data on the rating plate, such as model, serial number etc. This information can be found on the outer rim of the oven chamber when the door is opened and also on the back or side of the exterior of the oven.

Problem	Reason	Solution
The appliance does not work	No power	Check the fuse, replace if blown
Oven lighting does not work	Loose or damaged bulb	Replace bulb if blown (see page 29)
Display shows 0.00	The oven was disconnected from the mains or there was a temporary power cut	Set the current time (see page 8)
Fan does not work	Risk of overheating! Unplug the appliance immediately or switch off the main circuit breaker. Contact the Customer Care Department	

If the problem is not solved, disconnect the power supply and report the fault.

Important! All repairs must be performed by qualified service technicians

Error codes

If any errors are detected within the appliance, the programme is interrupted and an error code is shown on the display.

Typically an error code is the letter E followed by a number.

In the event of an error code being displayed, note the code and the corresponding reason and contact CDA Customer Care.

Specifications



Model	SL550SS	12247.3eTePrDpScJNkVUtX
	SL550BL	12247.3eTePrDpScJNkVUtS
	SL570SS	12247.3eTtePrDpScJNkVUtX
Oven Dimensions (HxWxD)	595 x 595 x 570 mm	
Rated voltage	220-240V [~] 50/60Hz	
Total rated input	2800 W	

This product meets the requirements of European standards EN 60335 -1; EN60335-2-6.

The data on the energy labels of electric ovens is given according to standard EN60350-1 / IEC60350-1. These values are defined with a standard workload with the following functions active:

Bottom and top elements (conventional heating) and fan assisted heating (forced air heating), if these functions are available.

The energy efficiency class was assigned depending on the function available in the product in accordance with the priority below:

Forced air circulation ECO (ring heater & fan)	 ECO
Forced air circulation ECO (bottom element + top + grill + fan)	 ECO
Conventional mode ECO (bottom element + top)	 ECO

Product fiche

The information in the product data sheet is given in accordance with the Commission Delegated Regulation (EU) NO 65/2014 supplementing Directive of the European Parliament and of the Council 2010/30/EU with regard to energy labelling of household ovens and range hoods.

Supplier name	CDA
Model identifier	SL550BL
	SL550SS
	SL570SS
	12247.3eTePrDpScJNkVUtS
	12247.3eTePrDpScJNkVUtX
	12247.3eTtePrDpScJNkVUtX
Energy efficiency index (EEI cavity)	81.6
Energy efficiency class	A+
Energy consumption per cycle (EC electric cavity)	0.99
Conventional mode [kWh]	0.71
fan-forced mode [kWh]	
Number of cavities	1
Heat source (electricity or gas)	Electric
Cavity volume (L)	77

In order to determine compliance with the eco-design requirements, the measurement methods and calculations of the following standard were applied:

EN 60350-1

Product information

Product information given in accordance with Commission Regulation (EU) No 66/2014 supplementing Directive of the European Parliament and Council Directive 2009/125/EC with regard to eco-design requirements for household ovens, hobs and range hoods.

Model identifier	SL550BL SL550SS SL570SS 12247.3eTePrDpScJNkVUtS 12247.3eTePrDpScJNkVUtX 12247.3eTtePrDpScJNkVUtX
Oven type (electricity or gas)	Electric
Appliance weight [kg]	38.9
Number of cavities	1
Heat source (electricity or gas)	Electric
Cavity volume (L)	77
Energy consumption needed to heat a standard charge in an electric oven cavity during a single cycle in conventional mode for each cavity (final electric energy consumption) EC electric cavity [kWh/cycle]	0.99
Energy consumption needed to heat a standard charge in an electric oven cavity during a single cycle in fan-forced mode for each cavity (final electric energy consumption) EC electric cavity [kWh/Cycle]	0.71
Energy efficiency index EEI cavity	81.6

Notes

The CDA Group

Harby Road

Langar

Nottinghamshire

NG13 9HY

Sales Department

Phone: 01949 862010

Email: sales@cda.eu

Customer Care Department

Phone: 01949 862012

Email: customer.care@cda.eu

