

|C|D|A|

SL200BL

Seven function electric oven with timer

Use and maintenance

Contents

3	Important information
5	First use of the oven
5	Using the electronic programmer
6	Setting the timer
7	Semi automatic cooking
8	Automatic cooking
9	Settings
10	Oven functions and operations
12	Using the grill
13	ECO heating
14	Practical tips
15	Cleaning and maintenance
21	Changing the oven light bulbs
22	Installation
24	Mains electrical connection
26	Technical assistance
27	Specifications
28	Product fiche
29	Product information

IMPORTANT: Please read the user instructions carefully before using the appliance for the first time and before installing it. Failure to install the oven, or to have it installed, as per the instruction manual could invalidate the warranty. Any service calls relating to misuse or incorrect installation could incur a service charge.

Important information

This appliance must only be used for the purpose for which it is intended, i.e. domestic cooking. Any other use could be dangerous and may lead to premature failure of the appliance.

The CDA Group Ltd. cannot be held responsible for injuries or losses caused by incorrect use or installation of this product. Please note that CDA reserves the right to invalidate the guarantee supplied with this product following incorrect installation or misuse of the appliance.

Under no circumstances should any external covers be removed for servicing or maintenance except by suitably qualified personnel.

User information

- The appliance and its accessible parts become hot during use. Care should be taken to avoid touching heating elements
- The appliance can be used by children aged from 8 years and above. Persons with reduced physical, sensory or mental capabilities must be given instruction or supervision concerning safe operation of the appliance and understand the hazards involved
- Do not allow anyone unfamiliar with the contents of this instruction manual to operate the oven
- Do not use harsh cleaning agents or sharp metal objects to clean the door as they can scratch the surface potentially resulting in cracking or shattering of the glass
- Take care when opening the oven door during or after a cooking cycle as hot steam may escape
- Do not use the oven in the event of a technical fault. Any faults must be fixed by an appropriately qualified and authorised person
- In the event of an incident due to a technical fault, disconnect the power and report the fault to CDA Customer Care
- The appliance has been designed only for cooking, any other use may invalidate your warranty and cause danger
- Do not place anything weighing over 15kg on the opened oven door

Appliance information

Please enter the details on the appliance rating plate below for reference, to assist CDA Customer Care in the event of a fault with your appliance and to register your appliance for guarantee purposes.

Appliance Model	
------------------------	--

Serial Number	
----------------------	--

IMPORTANT INFORMATION FOR CORRECT DISPOSAL OF THE PRODUCT IN ACCORDANCE WITH EC DIRECTIVE 2012/19/EU.

At the end of its working life, the product must be taken to a special local authority waste collection centre or to a dealer providing appliance recycling services.

Disposing of a household appliance separately avoids possible negative consequences for the environment and health. It also enables the constituent materials to be recovered, saving both energy and resources. As a reminder of the need to dispose of household appliances separately, the product is marked with a crossed-out wheeled dustbin .



First use of the oven

In order to remove oil residues accumulated during the manufacturing process and dust accumulated during storage and transport, we recommend a preliminary cleaning before first use. This is to protect your health and provide optimum quality in cooking.

Preliminary heating

1. Remove any packaging elements from the oven cavity
2. Turn on ventilation or extractor fan in the room or open a window
3. Set the oven to 250°C using the fan oven function
4. Allow to heat for approximately 30 minutes
5. Turn oven off and allow to cool
6. To clean the oven use a well wrung-out cloth with warm water and a small amount of washing up liquid
7. Dry with a clean cloth

A slightly unpleasant smell may be emitted during this process due to the vaporising of oil residue used to protect the oven during storage.

Do not use corrosive or abrasive powders when cleaning the appliance as they can damage the surface

Using the electronic programmer









- M - Select the mode of operation
- ⬆ - Increase setting sensor
- ⬇ - Decrease setting sensor
- 🔥 - Appliance on indicator
- 🔔 - Minute minder
- || - Duration
- ⇒ - End time

This oven's electronic timer is equipped with touch control sensors. Each registered touch of the sensor is confirmed by a single beep. It is recommended to keep the touch sensors clean at all times for ease of operation.

Setting the time











When first connected to the power supply, the digital display will flash **0.00**. The oven will not operate until the time is set.

- Simultaneously touch  and  until you see the dot below the  symbol flashing
- Touch  or  within 7 seconds to set the current time. Once the desired time is set, allow 7 seconds for the dot to stop flashing followed by a beep. The time can be adjusted again at any time by pressing  and  simultaneously and following the same steps

Minute minder

You can activate the minute minder at any time regardless of the status of other functions. It can be set from 1 minute up to a maximum of 23 hours and 59 minutes.

To set the minute minder:

- Touch and hold  and the display will show a flashing 
- Use the  and  sensors to set the time desired. The display will show the set time and the  symbol will be visible
- Once the set time elapses an alarm will sound and the  icon flashes. Touch and hold either  /  or  to mute the alarm. After approximately 7 seconds the  will be off and the display will show the current time













Please note:

If no sensor is touched the alarm will turn off automatically after approximately 7 minutes.

Semi-automatic cooking

This function allows for a cooking time to be set. When the set time elapses the oven will switch the set function off and an acoustic signal will sound to alert the user. The cooking time available ranges from between 1 minute and 10 hours.











To switch on semi-automatic cooking







- Set the desired oven function and temperature
- Touch  repeatedly until the display shows **dur** (duration) and the  symbol is flashing
- Set the desired duration from between 1 minute and 10 hours using the  /  sensors
- The set duration will be memorised after 7 seconds and the display will show the current time and the  symbol
- Once the duration time has elapsed the oven will turn off automatically. You will hear an alarm and the  and  symbols will flash
- Set the function and temperature selection knobs to the off position
- Touch and hold the  /  or  to mute the alarm
- The  and  will go off and the display will revert to the current time after approximately 7 seconds

Automatic cooking





This function allows for a duration and an end time to be set for cooking. For example, if you set the cooking duration to 1 hour, and the end time to 15:00, then the oven will activate the function at 14:00.

To switch on automatic cooking





- Touch  repeatedly until the display shows **dur** (duration) and the  symbol is flashing
- Set the desired duration using the  / 
- Touch  repeatedly until the display shows **End** and the  symbol is flashing
- Using the  /  set the end time of the cycle up to a maximum of 23 hours and 59 minutes
- Set the function selector knob and temperature selector knob to the desired settings. The  and  will be illuminated on the display and are now active. The appliance will now switch on at the end time minus the duration set

Once the duration time has elapsed the oven will turn off automatically. The alarm will be heard and the  and  symbols will flash. Set the function and temperature selector knobs to the off position then touch and hold the  /  or  to mute the alarm. The  and  will be off and the display will show the current time after approximately 7 seconds.

Cancel settings

Timer and function settings can be cancelled at any time regardless of the status of the operation. Simultaneously touch  /  to cancel. In order to cancel the minute minder function, first hold down  and then simultaneously touch  /  to cancel.





Changing the beep tone

- Simultaneously touch and hold  / 
- Touch  repeatedly until the display shows **Ton1**
- Touch  /  to select between **Ton1**, **Ton2** and **Ton3**

Adjusting the display brightness

You can adjust the brightness of the display from 1 to 9, 1 being the darkest and 9 the brightest. The brightness setting applies when no controls are touched for 7 seconds.

You can adjust display brightness as follows:

- Simultaneously touch and hold the  / 
- Touch  repeatedly until **Bri** shows on the display
- Use the  /  sensors to select between 1 and 9

Night mode

The display is dimmed during the hours of 22:00 - 06:00

Oven functions and operation

The ovens operations are controlled by the function selector knob on the right side of the control panel and the temperature selector knob on the left side.

Please note:

Only when the temperature has been selected will the oven begin to heat up.

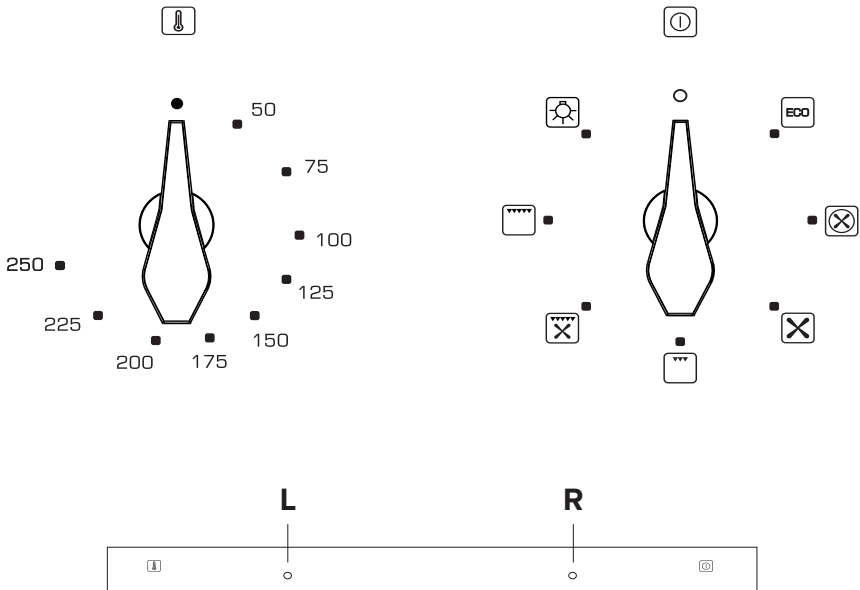

Switching on the oven is indicated by two signal lights, **L** and **R**. When **R** is illuminated it signifies the oven is working. The **L** light indicates the temperature has been set; once this light goes out it means the desired temperature setting has been reached. If a recipe recommends placing dishes in a preheated oven, this should not be done until the **L** light goes out for the first time. When baking, the **L** light will temporarily come on and go out indicating temperature is being maintained inside the oven.

Oven functions and operation

○/● **Oven is off**



Eco heating

This is an optimised heating function designed to save energy. When using this function the oven light is intentionally left off.



Fan oven

This function uses the circular heating element with a temperature between 50°C and 250°C. The fan then circulates the hot air which helps to achieve uniform heat distribution.



Defrost

This function uses the fan to circulate air at ambient temperature within the oven which helps to accelerate the defrosting process.



Half grill

This function radiates heat from the grill element. This fully temperature variable grill can be set between 50°C and 250°C maximum.



Fanned full grill

This function radiates heat from the grill element and the top element but also uses the fan to circulate the hot air. The hot air is distributed over and under the food that you are grilling. This fully temperature variable grill is ideal for grilling fish or other foods where the appearance could be spoiled by a normal grill function. It can be set between 50°C and 190°C maximum.



Full grill

This function radiates heat from the grill element and the top element. This fully temperature variable grill is ideal for grilling a full family meal. It can be set between 50°C and 250°C maximum.



Light

The oven light will be turned on.

Using the grill

Important!

When using any grill function the oven door should be kept closed. When the grill is in use accessible parts can become hot; it is advisable to keep children away from the oven.







In order to switch on the grill you need to:

- Set the function selector knob to the desired grill setting
- Heat the oven for approximately 5 minutes with the oven door shut
- Insert a tray on to the appropriate cooking level; if you are grilling food directly on the wire shelf, place a tray on the level immediately below
- Close the oven door

When using the half grill or full grill functions the maximum temperature that can be set is 220°C. The maximum the fanned full grill can be set to is 190°C.









ECO heating

ECO heating is an optimised heating function designed to save energy when preparing food. You cannot reduce the cooking time by setting a higher temperature; preheating the oven is not recommended. Do not change the temperature setting and do not open the oven door during cooking. The levels listed in the table below can be found around the edge of the oven cavity when the door is open

Type of dish	Oven function	Temperature °C	Level	Time (min)
Sponge cake		180 - 200	2-3	50 -70
Muffins		180 - 200	2	50 -70
Fish		190 - 210	2-3	45 - 60
Beef		200 - 220	2	90 - 120
Pork		200 - 220	2	90 - 160
Chicken		180 - 200	2	80 - 100

Practical tips

The times given in the table below apply to a dish that is placed in to a cold oven. For a preheated oven the times should be reduced by 5 - 10 minutes. The figures given below are approximate and can be altered based on your own experience and cooking preferences. The levels listed in the table below can be found around the edge of the oven cavity when the door is open

Type of dish	Heating Function	Level	Time [Min]	Temperature [°C]
Muffins		3	25 - 40	155 - 170
Fish		2 - 3	45 - 60	160 - 180
Fish		2 - 3	60 - 70	190
Sausages		4	14 - 18	220
Beef		2	120 - 160	160 - 180
Pork		2	90 - 120	160 - 190
Chicken		2	70 - 90	180 - 190
Chicken		2	60 - 70	175 - 190
Vegetables		3	40 - 50	170 - 190

Cleaning and maintenance

Keeping your oven clean and well maintained helps to prolong its fault-free lifespan. It is important that, before any cleaning or maintenance is performed, you switch off the oven at the mains supply. Do not start any cleaning or maintenance until the oven has been allowed to cool completely.

We recommend always wearing PPE (Personal Protective Equipment) when carrying out any cleaning or maintenance.

Cleaning the oven exterior

Stainless steel, aluminium and glass surfaces can all be cleaned using a dilute solution of water and mild detergent. They must be cleaned very carefully using a soft or microfibre cloth to avoid scratching and abrasions. Any abrasive cleaner (including Cif) will scratch the surface and could erase the control panel markings. Always dry thoroughly with a soft dry cloth.

Cleaning the oven interior

The oven should always be cleaned after use when it has been allowed to cool down. The cavity should be cleaned using a mild detergent solution and warm water and then wiped dry with a suitable clean cloth.

Cleaning and maintenance

Abrasive cleaning agents or scouring pads/cloths should not be used on the cavity surface.

IMPORTANT:

- **Steam cleaners must not be used when cleaning this appliance.**
- **Once care and maintenance is complete, ensure that all parts are correctly replaced before using the oven.**

Removing the appliance door

In order to allow easier access into the oven cavity for cleaning, it is possible to remove the door. Before removing the door, ensure that you have an area prepared in which you can place the removed door. This area should ideally be protected by something like a folded, dirt-free, towel to help prevent damage to surfaces and the door.

- Open the door fully
- Lift and tilt the safety catch part of the hinge (Fig. 1) so that it is fully extended and points towards the door
- Close the door most of the way, lift it slightly and then pull it, safely but firmly, towards you

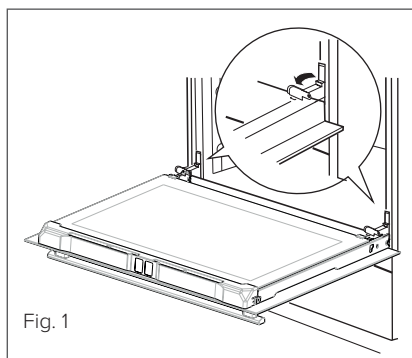

Cleaning and maintenance

Replacing the appliance door

- Hold the door to the appliance in the closed position and manoeuvre the hinges so that the part of the hinge, highlighted by the star in fig. 2, inserts into the hinge slot in the cavity frame
- Next, ensure the notch on the underside of the hinge sits on the lip of the hinge slot. Open the door fully. Each hinge should be seated in the same way as the hinge in fig. 3. If it is not, follow the steps for removing the door and try replacing it again
- Finally, lift the safety catch part of the hinges back into place so that they are lying flat against the hinges

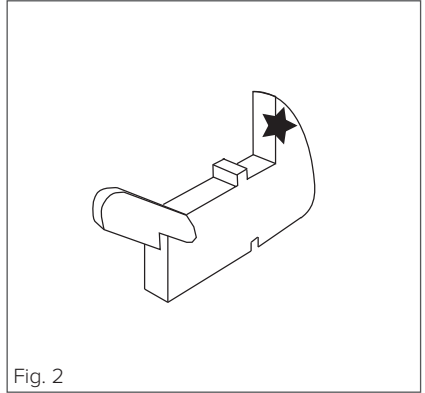

Fig. 2

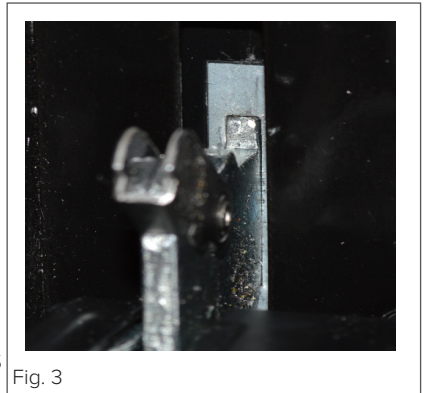

Fig. 3

Please note: If the hinge safety catches are not in the correct place then the door and/or appliance may receive damage when attempting to close the door.

Cleaning and maintenance

Important: Do not disassemble the door without it having been removed from the oven. Weight differences could cause the door to snap shut, causing damage to the oven and/or the user

Removing the inner door glass

With the door removed, the inner glass can also be taken out for cleaning purposes.

- Squeeze the locking tabs on either side of the oven door, freeing the door slat as per fig. 4
- Remove the door slat, as per fig. 5, and place it somewhere safe where it will neither receive nor cause damage
- Remove the inner glass from the blocks it is seated within (near to the hinges) and place this somewhere safe also. Pay attention to the way that the glass is facing as it will need to be replaced in the same direction. The smooth surface of the glass should be facing upwards (inwards if the door was back in place) with the patterned side facing the oven door handle
- Clean the door glass with warm, soapy water and wipe dry with a clean microfibre cloth

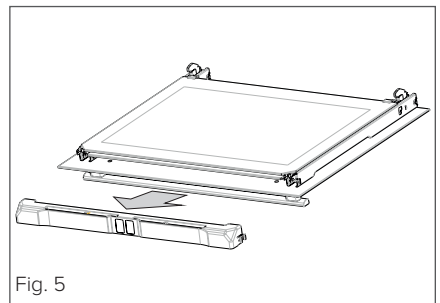
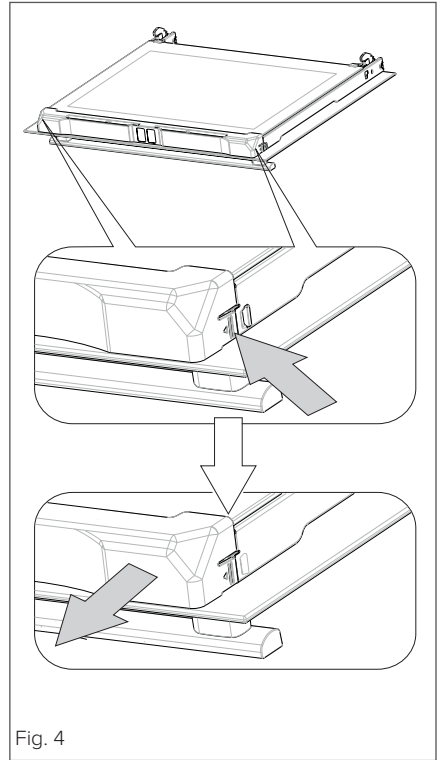

Cleaning and maintenance

- The middle pane of glass can also be removed but it is important that this pane is reinserted facing the same way that it was when removed
- There are a number of rubber guides attached to the inner pane and these must be returned to their original positions when reassembling the door. Fig. 6 shows these guides and their position on and around the inner glass
- Simply reverse these steps in order to reassemble the door. Take care when reattaching the upper door slat. Place the left side on first until you hear a 'click' as it connects and then attach the right side. This will help to avoid damaging the door and/or glass

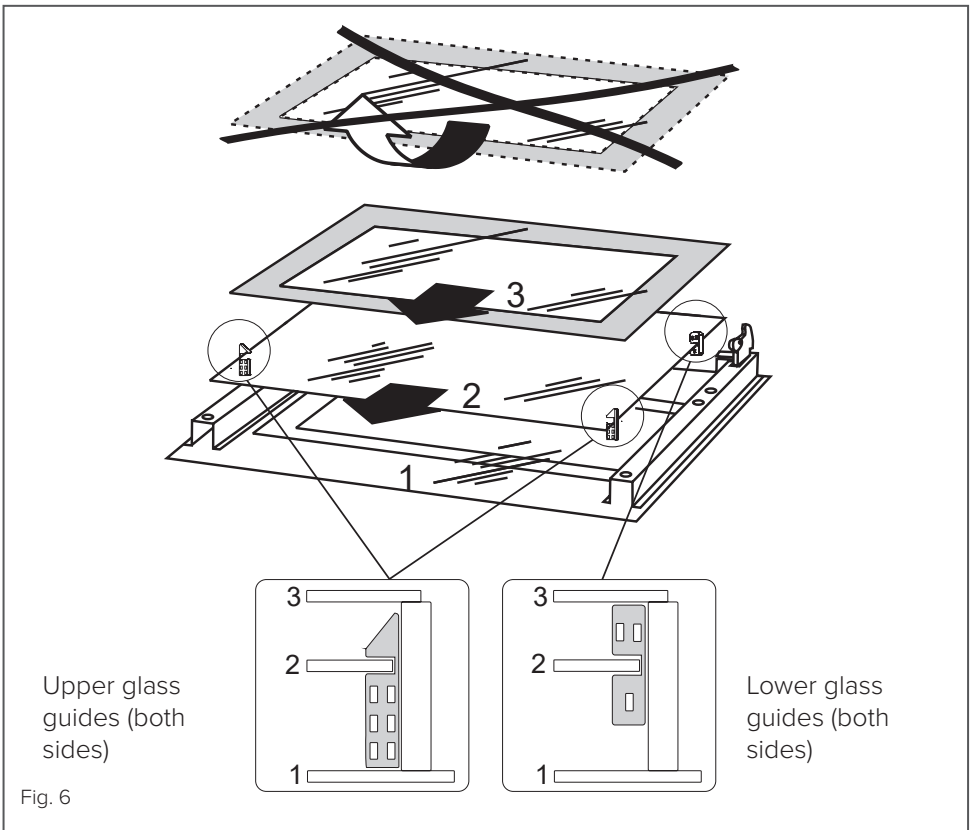

Cleaning and maintenance

Important:

Always remember to allow the oven to cool sufficiently, if it has been in use, before carrying out any maintenance.

To remove the shelf supports

- Take a firm hold of the shelf support in the middle. Place your thumb against the oven wall and lever the support out of the support holes (Fig. 7)
- Tilt the shelf support outwards (Fig. 8) and you should then be able to remove the shelf support arms that secure it into the cavity walls at the back

To replace the shelf supports

- Simply carry out the above steps, but in reverse order

Please note:

Take care not to damage the enamel walls of the oven, particularly around the shelf support arm holes.

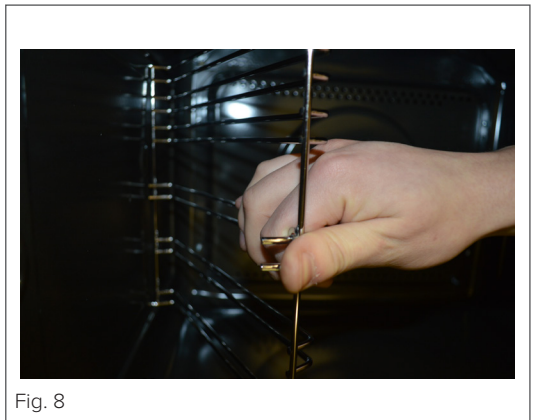
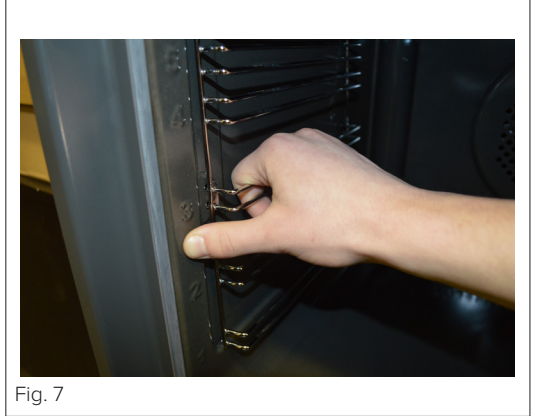

Changing the oven light bulbs

Important:

Before any maintenance is started involving electrical parts, the appliance must be disconnected from the power supply.

If the oven has been in use, let the oven cavity and the heating elements cool down before attempting any maintenance.

Never use screwdrivers or other utensils to remove the light cover. This could damage the enamel of the oven or the lamp holder. Remove only by hand.

Never replace the bulb with bare hands as contamination from your fingers can cause premature failure. Always use a clean cloth or gloves. Old bulbs may also be hot!

Changing the bulb (Fig. 9)

- Remove any cookware, shelves and shelf supports as shown on page 20
- Carefully detach the glass cover by applying pressure with your thumb to one side whilst holding the other side with your fingers.
- Carefully remove the old bulb and insert a new bulb suitable for high temperatures (300°C) of the following specification; 230-240V~, 50Hz, 25W, G9 fitting
- Refit the glass cover

Please note:

The bulb replacement is not covered by your guarantee.



Installation

Important! If installing this oven below a hob, ensure that the required air gap between the two appliances is observed. This gap is usually detailed in the hob's manual.

The installation of this appliance must be carried out by a suitably qualified person. We recommend seeking the help of another person for the installation process.

If the oven is being installed into a built under oven housing unit ensure that the front rail at the top of the unit is not installed as it could restrict ventilation.

Ensure that air can flow freely around the housing area. If the oven is being installed into a fully enclosed built-under oven housing unit it may be necessary to cut a small slot in the top of the plinth fitted under the unit. Cut a section 400mm wide and a minimum of 15mm high to allow air to pass under the unit. Alternatively cut a section 400 x 450

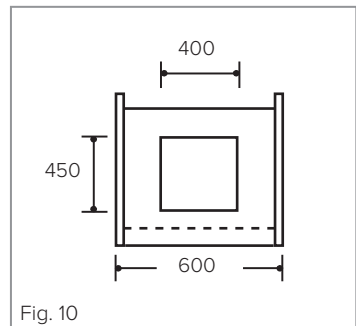

mm in the base of the carcass as indicated in fig. 10. Failure to allow adequate ventilation to the appliance may result in overheating or damage to adjacent units and could invalidate the warranty.

This appliance is type X installation.

Installation

The walls of the kitchen units must be able to withstand temperatures of 75°C above ambient (typically this is between 90°C and 100°C). When correctly installed ensure that there is a gap of 4mm minimum between the sides of the oven and adjacent furniture doors.

How to install your oven

You will need the housing area in fig. 11 to fit your oven correctly. The oven is designed to fit into a cabinet of 600 mm width. The oven can be built in or built under the kitchen units, but you must ensure that it is properly ventilated. In the diagram below the built-in oven is ventilated by means of a space at the top of the kitchen cabinet. There are many other methods of ventilating your oven - consult a qualified engineer for advice.

Lift the oven carefully into position on the shelf, taking care NOT to lift it by the door handle. If you lower the oven door, you will see 4 screw holes, 2 on each side of the oven (image B fig. 11). The oven should then be secured to the housing by securing screws into these holes. Remember the housing should not be free-standing but be secured to the wall and/or adjacent fittings.

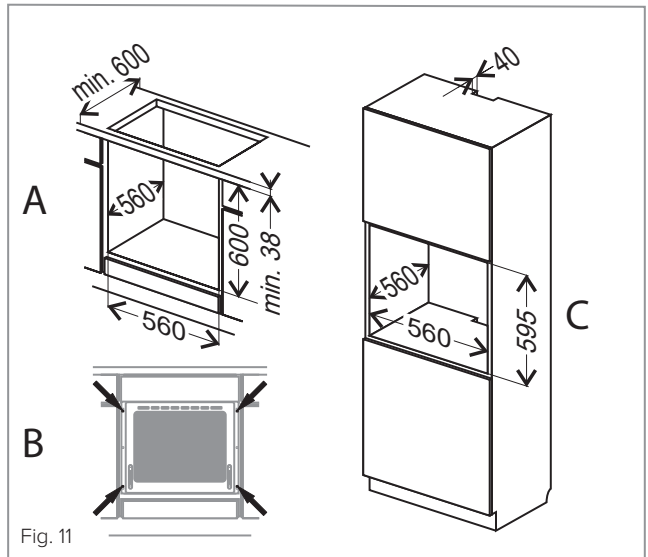

Fig. 11

Remember the housing should not be free-standing but be secured to the wall and/or adjacent fittings.

Mains electrical connection

Warning! This appliance must be earthed.

This appliance must be connected by a competent person, using fixed wiring via a double pole switched fused spur outlet, protected by a 13A fuse.

We recommend that the appliance is connected by a qualified electrician, who is a member of the N.I.C.E.I.C. and who will comply with the I.E.T. and local regulations. The wires in the mains lead are coloured in accordance with the following code:

GREEN AND YELLOW = EARTH
BLUE = NEUTRAL
BROWN = LIVE

As the colours of the wires in the mains lead for the appliance may not correspond with the coloured markings identifying the terminals in your spur box, proceed as follows:

1. The wire which is coloured green and yellow must be connected to the terminal marked E (Earth) or coloured green
2. The wire which is coloured blue must be connected to the terminal marked N (Neutral) or coloured black
3. The wire which is coloured brown must be connected to the terminal marked L (Live) or coloured red

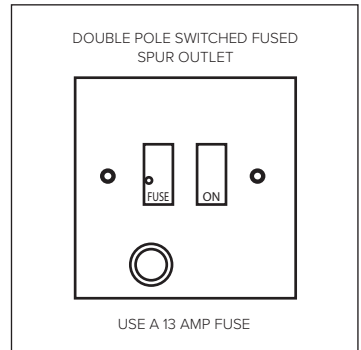

Mains electrical connection

Please note:

- The mains cable must only be replaced by a qualified electrician or service engineer and must be of equivalent or better rating (i.e. 3 x 1.5 mm², HO5VV-F)
- This appliance is intended to be connected to the mains supply with a cable of cross sectional area 1.5 mm²
- The current rating of the fuse or circuit breaker protecting this appliance should be marked on the socket outlet
- Assembly and electrical connection should be carried out by specialised personnel
- When installing this product we recommend you seek the help of another individual
- Should the mains cable be damaged or need to be replaced, it should only be done so by a qualified electrician or engineer. The terminal block on the appliance is clearly marked with regards to the positions of live, neutral and earth

Appliance electrical rating: 2800W

Technical assistance

In the event of your appliance requiring technical assistance and/or spare parts, please contact CDA Customer Care

CDA Customer Care

Phone: 01949 862 012

Email: customer.care@cda.eu

In this case it is necessary to state all the appliance data on the rating plate, such as model, serial number etc. This information can be found on the outer rim of the oven chamber when the door is opened and also on the back or side of the exterior of the oven.

Problem	Reason	Solution
The appliance does not work	No power	Check the fuse, replace if blown
Oven lighting does not work	Loose or damaged bulb	Replace bulb if blown (see page 19)
Electronic programmer display shows 0.00	The oven was disconnected from the mains or there was a temporary power cut	Set the current time (see page 6)
Fan does not work	Risk of overheating! Unplug the appliance immediately or switch off the main circuit breaker. Contact the Customer Care Department	

If the problem is not solved, disconnect the power supply and report the fault.

Important! All repairs must be performed by qualified service technicians

Specifications



Model	SL200BL
Oven Dimensions (HxWxD)	595 x 595 x 575 mm
Rated voltage	230 V ~ 50 Hz
Total rated input	2800 W

This product meets the requirements of European standards EN 60335 -1; EN60335-2-6.

The data on the energy labels of electric ovens is given according to standard EN60350-1 / IEC60350-1. These values are defined with a standard workload with the following functions active:

Bottom and top elements (conventional heating) and fan assisted heating (forced air heating), if these functions are available.

The energy efficiency class was assigned depending on the function available in the product in accordance with the priority below:

Forced air circulation ECO (ring heater & fan)	 ECO
Forced air circulation ECO (bottom element + top + grill + fan)	 ECO
Conventional mode ECO (bottom element + top)	 ECO

Product fiche

The information in the product data sheet is given in accordance with the Commission Delegated Regulation (EU) NO 65/2014 supplementing Directive of the European Parliament and of the Council 2010/30/EU with regard to energy labelling of household ovens and range hoods.

Supplier name	CDA
Model identifier	SL200BL
	12246.3eEdTsDVS
Energy efficiency index (EEI cavity)	95,4
Energy efficiency class	A
Energy consumption per cycle (EC electric cavity)	
Conventional mode [kWh]	0.99
fan-forced mode [kWh]	0.83
Number of cavities	1
Heat source (electricity or gas)	Electric
Cavity volume (L)	77

In order to determine compliance with the eco-design requirements, the measurement methods and calculations of the following standard were applied:

EN 60350-1

Product information

Product information given in accordance with Commission Regulation (EU) No 66/2014 supplementing Directive of the European Parliament and Council Directive 2009/125/EC with regard to eco-design requirements for household ovens, hobs and range hoods.



Model identifier	SL200BL
	12246.3eEdTsDVS
Oven type (electricity or gas)	Electric
Appliance weight [kg]	31,8
Number of cavities	1
Heat source (electricity or gas)	Electric
Cavity volume (L)	77
Energy consumption needed to heat a standard charge in an electric oven cavity during a single cycle in conventional mode for each cavity (final electric energy consumption) EC electric cavity [kWh/cycle]	0.99
Energy consumption needed to heat a standard charge in an electric oven cavity during a single cycle in fan-forced mode for each cavity (final electric energy consumption) EC electric cavity [kWh/Cycle]	0.83
Energy efficiency index EEI cavity	95.4

Notes

Certificate of compliance CE and UKCA.

The Manufacturer hereby declares that this product complies with the general requirements pursuant to the following European Directives and analogous UK requirements :

- The Low Voltage Directive 2014/35/EC / Electrical Equipment (Safety) Regulations 2016.
- Electromagnetic Compatibility Directive 2014/30/EC / Electromagnetic Compatibility Regulations 2016.
- ErP Directive 2009/125/EC / The Ecodesign for Energy-related Products Regulations 2010 (as amended) for the applicable implementing measures which apply in Great Britain and Northern Ireland, respectively.

and therefore the product has been marked with  and  symbols and the Declaration of Conformity, the Manufacturer has drawn up the declaration and is available to the competent authorities regulating the market.

Notes

The CDA Group

Harby Road

Langar

Nottinghamshire

NG13 9HY

Sales Department

Phone: 01949 862010

Email: sales@cda.eu

Customer Care Department

Phone: 01949 862012

Email: customer.care@cda.eu

